



BRAKE PARTS



wedex
PARTS

Product Catalog
Spare Parts

2015/02

www.wedexparts.com

A "Altun Automotive" Brands.

BRAKE SHOES













| | | | | | |
|--|--|---|---|---|---------------------------------|
|  | H-21101 | FMSI 4515 E-4515 16.5X7" |  | H-21107 | FMSI 4707 E-4707 16.5X7" |
|  | H-2101E | FMSI 4515 E-4515E 16.5X7" |  | H-21102 | FMSI 4702 E-9062 15X4" |
|  | H-21103 | FMSI 4515X E-5487 |  | H-21104 | FMSI 1443 E-9027 |
|  | H-21105 | FMSI 4551, E-3713 16½X8⅝" |  | H-21106 | FMSI 4311 E-2819 16.5X7" |
|  | H-21108E | FMSI 1308Q E-5139 15X4" |  | H-21108Q | FMSI 1308E E-5528 15X4" |
|  | H-21109 | FMSI 4709 Eaton E-5480 |  | H-21110 | FMSI 4524 Q E-3303 |
|  | H-21112 | FMSI 4718 Q+ E-10850 ES930266 |  | H-21113 | FMSI 4720 Q+ E-10854 |
|  | H-21114 | FMSI 4516 / 4644 |  | H-21114T | FMSI 4516 / 4644E ES930264 |
|  | H-21159 | FMSI 4656 410x180 |  | H-21160 | FMSI 4657 410x220 |
|  | H-21167 | FMSI 4715 |  | H-21168 | FMSI 4728 |
|  | H-21121 | 05.091.26.64.2 420X180 |  | H-21126 | 05.091.14.19.0 300X200 |
| | H-21122 | 05.091.27.54.2 420X200 | | H-21127 | 05.091.19.34.0 360X200 |
|  | H-21123 | 05.091.46.17.0 420X180 |  | H-21223 | 05.091.46.09 420X180 |
| | H-21124 | 05.091.27.83.0 420X200 | | H-21224 | 05.091.27.79 420X200 |
| | H-21125 | 05.091.27.82.1 420X220 | | H-21225 | 05.091.28.26 420X220 |
|  | H-21132 | A 393 420 07 19 MERCEDES 410x160 |  | H-21135 L/R | 3095195-8 VOLVO BMC 410x175 |
| | H-21133 | A 620 420 00 19 MERCEDES 410x180 | | H-21136 L/R | 3095196-6 VOLVO BMC 410x200 |
|  | H-21134 | A 620 420 05 19 MERCEDES 410x220 | | H-21137 L/R | 3095194-4 VOLVO BMC 410x225 |
|  | H-21161 H-21162 H-21163 | DÖKÜM 410x160 DÖKÜM 410x180 DÖKÜM 410x220 |  | H-21135N L/R H-21136N L/R H-21137N L/R | VOLVO BMC CARGO 2010 Sonrası |
|  | H-21141 | IVECO |  | H-21138 H-21139 | CARGO 175 CARGO 200 |

SHOE BOX KITS

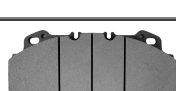
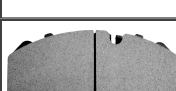
| | REF | REF / Size / Kit in Box | Kit in Box | | |
|--|----------------|--------------------------|---|-----------------|-------------------------|
|  | H-21401 | 4515Q/16½X7"/H-24101HD |  | H-21401E | 4515E/16½X7"/H-24101HD |
| | H-21402 | 4702 15X4" H-24111 | | H-21407 | 4707Q+/16½X7"/H-24101HD |
| | H-21403 | 4515X3/16.5X7"/H-24102HD | | H-21408Q | 1308Q/15X4"/H-24106 |
| | H-21404 | 1443/15x4"/H-24107 | | H-21408E | 1308E/15X4"/H-24107 |
| | H-21405 | 4551/16½X8⅝"/H-24101HD | | H-21409 | 4709/16.5X7"/H-24109 |
| | H-21406 | 4311/16.5X7"/H-24103HD | | H-21410 | 4524Q/16.5X5"/H-24101HD |
|  | H-21201 | 4515 Q / 16.5X7" |  | H-21206 | 4311 / 16.5X7" |
| | H-21202 | 4702 / 15X4" | | H-21207 | 4707 Q+ / 16.5X7" |
| | H-21203 | 4515X / 16.5X7" | | H-21208Q | 1308Q / 15X4" |
| | H-21204 | 1443 / 15X4" | | H-21208E | 1308E / 15X4" |
| | H-21205 | 4551 / 16½X8⅝" | | H-21409 | 4709 / 16.5X7" |

DISK PAD











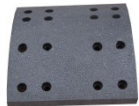

| | | | | | |
|--|----------------------------------|--|---|----------------|---|
|  | H-29011 | 3525 IVECO 440E / 42 EUROARGO EUROSTAR EUROTECH |  | H29115 | 3908 MAN TGL- MERCEDES Atego |
|  | H-29030 H-29084 | 3497 0403/404 MAGNUM MAN 2000 |  | H-29065 | IVECO, 65 / 79, EUROARGO 60E/65E/75E |
|  | H-29125 | VOLVO FH-12 |  | H-29131 | 3828 RENAULT Magnum Premium 370/420 MAN TGA F2000 |
|  | H-29087 H-29095 | 3664 NEOPLAN MAN AXOR ACTROS TRAVEGO BPW SCANIA KOGEL |  | H-29088 | 3565 MAN 12.153 M2000 BMC215 SETRA |
|  | H-29090 | 3770 RENAULT 385 / 400 Magnum Premium DXI |  | H-29093 | 0404 Atego |
|  | H-29105 H-29167 | 3664 MAN MERCEDES SETRA SCANIA DAF IVECO |  | H-29142 | BENZ RENAULT DAF |
|  | H-29162 | 3839 BPW RVI 50 SAF SK-RB SK |  | H-29165 | 3789 BPW SKH-SERIES SB-3745 |
|  | H-29171 | ATEGO/SAF/SHMITZ MAN 2000 |  | H-29174 | 3917 FCV4378BFE Renault Premium 430-440-450-460 DXI |











LININGS



| | | | | | |
|--|----------------|---|---|----------------|---|
|  | H-21580 | MB/74/75-19579/80 56265 MERCEDES 0302 S- MARATON F |  | H-21534 | RN/100/1 19934 - 5887 Renault |
| | H-21582 | MB/76/77-19581/82 56266 MERCEDES 0302 S- MARATON R | | H-21535 | RN/101/1 cd5 - 5888 Renault |
|  | H-21586 | MP/31/2-19486-56250 F3539 MAN SUPERMAN - MERCEDES F |  | H-21538 | VL/87/1 - 19938 5880 BMC VOLVO CARGO175 mm |
| | H-21587 | MP/32/2 - 19487 - 5623 MAN SUPERMAN - MERCEDES R | | H-21539 | VL/88/1 - 19939 5880-20 BMC VOLVO CARGO 200 mm |
| | H-21588 | MP/36/1-19488-56268 K19488 MAN SUPERMAN - MERCEDES R | | H-21540 | VL/89/1 - 19940 5880-22.5 BMC VOLVO CARGO 225 mm |

| | | | | | |
|--|----------------------------------|---|---|---|--|
|  | H-21501 H-21515 | 19036/37 – 5266 - 4515 DODGE HINO – ROR - FRUEHAUF |  | H-21520 | CW/11/1 19887 – 5878 CARGO – FATİH ÖN |
|  | H-21532 | BC/98/1 - 19032 – 687 18 cm BPW - SERIN – DORSE DİNGİL |  | H-21521 | CW/12/1 - 19921 - 5878-20 CARGO – FATİH ARKA |
|  | H-21594 | BC/97/1 - 19094 – 689 20 cm BPW - SERIN – AXLE | | H-21556 | RW 28/1 – 19956 |
|  | H-21550 | DF/20/21 19150/51 54013 |  | H-21554 | RW 29/1 19954 5897 |
|  | H-21590 | DF/32/33 19890/91 54015 | | H-21566 | RW/1/2 - 19365/66 – 5266 |
|  | H-21590 | DF/32/33 19890/91 54015 |  | H-21591 | DF/32/33 19890/91 54016 |
|  | H-21520K | SY/20/2 - 17635 54563K BMC CARGO |  | H-21570 | FU/4/5/1 19369/70 – 5275 |
| | H-21526U | SY/26/1 - 17636 54563U BMC CARGO | |  | H-21541 H-21542 H-21543 |

Manual & Automatic Slack Adjusters

| | | | | | | | |
|--|----------------|----------|-----------------|---|-----------------|----------|-----------------|
|  | H-26411 | 40010211 | 28x5.5" |  | H-26404 | 40010304 | 28x5.5" |
| | H-26412 | 40010212 | 28 x 6" | | H-26405 | 40010305 | 28 x 6" |
| | H-26413 | 40010213 | 37 x 5.5" | | H-26406 | 40010306 | 10 x 5.5" |
| | H-26414 | 40010214 | 37 x 6" | | H-26407 | 40010307 | 10 x 6" |
| | H-26415 | 40010215 | 10 x 5.5" | | | | |
| | H-26416 | 40010216 | 10 x 6" | | | | |
|  | H-26440 | 40010140 | 10 x 5.5" |  | H-26444 | 40010144 | 28 x 6" |
| | H-26441 | 40010141 | 10 x 6" | | H-26445 | 40010145 | 10 x 6" |
| | H-26442 | 40010142 | 28x5.5" | | H-26446 | 40010146 | 28x5,5-6.5" |
| | H-26443 | 40010143 | 28 x 6" | | | | |
|  | H-26491 | 10566 | Mounting Kit |  | H-26493 | 10563 | Mounting Kit |
|  | H-26307 | E-6991 | 10 x 6" |  | H-26311 | E-6995 | 28x5.5" |
| | H-26308 | E-6992 | 10 x 5.5" | | H-26312 | E-6996 | 28 x 6" |
| | H-26309 | E-6993 | 28 x 6" | | H-26322 | E-6987 | 1 ¼"-10 |
| | H-26310 | E-6994 | 28x5.5" | | H-26324 | E-6988 | 1 ¼"-24 |
|  | H-26501 | R801041 | 10 x 5.5" |  | H-26511L | R802332 | 10 x 5.5"L |
| | H-26502 | R801042 | 10 x 6" | | H-26511R | R802333 | 10 x 6"R |
| | H-26503 | R801073 | 28x5.5" | | H-26512L | R802334 | 10 x 5.5"L |
| | H-26504 | R801074 | 28 x 6" | | H-26512R | R802335 | 10 x 6"R |
| | H-26505 | R801001 | 1 ¼"-10 | | H-26513L | R802486 | 28x5.5"L |
| | H-26506 | R801002 | 1 ¼"-24 | | H-26513R | R802487 | 28 x 6"R |
| | H-26507 | R801101 | 1 5/8"- 37 | | H-26514L | R802488 | 28x5.5"L |
| | H-26508 | R801102 | 1 5/8"- 37 | | H-26514R | R802489 | 28 x 6"R |













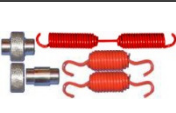

| | | | | | | | |
|--|----------------|---------------------------------------|--|---|------------------------------------|---|--|
|  | H-80000 | 5018/527/3879 70952 72617 72966 | N42x1.5x12 DIN 5480 26 Spline |  | H-80001 | 5017/527/3878 70953 72616 72965 | N42x1.5x12 DIN 5480 26 Spline |
|  | H-80008 | 5016 / 528 | N42x1.5x12 H DIN 5480 26 Spline |  | H-80009 | 5015 / 528 | N42x1.5x12 H DIN 5480 26 Spline |
|  | H-80010 | 5020 / 527 / 3185 | N42x1.5x12 H DIN 5480 26 Spline |  | H-80011 | 5019 / 527 / (3186) | N42x1.5x12 H DIN 5480 26 Spline |
|  | H-80019 | 5027 / 530 / 4076 72875 / 72876 | SAE 1½" 10 Spline |  | H-80020 | 5027 / 530 / 4076 72788 / 79235 | SAE 1½" 10 Spline |
|  | H-80021 | 5027 / 530 / 4086 79022 | SAE J 498 37 Spline |  | H-80022 | 5027 / 530 / 4076 72948 / 79005 79035 / 79109 79149 / 79240 72703 / 72758 | SAE 1½" 10 Spline |
|  | H-26102 | 1 1/2"-10 | 5"- 6"- 7" |  | H-26121 | 1 1/2"- 8 | 5"- 6"- 7" |
| | H-26104 | 1 1/2"-10 | 5.5"- 6.5" |  | H-26163L H-26164R | 1 1/2"-10 1 1/2"-10 | 5"- 6"- 7" |
| | H-26106 | 1 1/2"-28 | 5"- 6"- 7" | | H-26165L H-26166R | 1 1/2"-10 1 1/2"-28 | 5"- 6"- 7" |
| | H-26108 | 1 1/2"-28 | 5.5"- 6.5" |  | H-26209 H-26210 | 1 1/2"-10 4 Holes | 12.7mm 14 mm |
| | H-26109 | 1 5/8"-37 | 5"-6" |  | H-26211 H-26212 | 1 1/2"-10 5 Holes | 18 mm 14 mm |
| | H-26110 | 1 5/8"-37 | 5.5"-6.5" |  | H-26251 | 1 1/2"-10 7 Holes | 12.7mm |

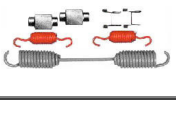
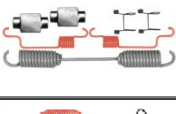
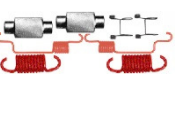



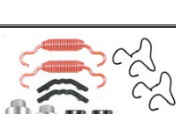



















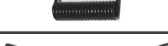



AIR BRAKE CHAMBERS





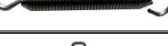



















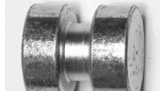

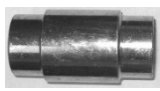



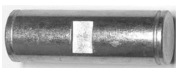
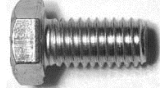



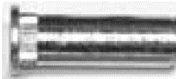

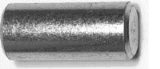
| | | | | | | | |
|--|--|----------------------------------|--------------------------------|---|--|------------------------------------|-------------------|
|  | H-28101 H-28102 H-28103 | 24x24 DD 24x30 DD 30x30 DD | NPT 3/8" & ¼" 5/8" - 18" |  | H-28104 H-28106 | 24x24 DD 30x30 DD | M16X1.5 280 mm |
|  | H-28105 H-28105D | 24x30 DD Stroke 76mm | M16X1.5 |  | H-28139 | T36 Stroke 76mm | M16X1.5 |
|  | H-28110 H-28111 H-28112 H-28113 | T16" T20" T24" T30" | 3/8" / 5/8" |  | H-28116 H-28116D H-28117 H-28117D | T24" T24" LS T30" T30" LS | M16X1.5 |

| | | | | | | | |
|--|---|--|---------|---|--|--|---------|
|  | H-28119 H-28120 H-28121 H-28121X H-28122 | 16x24 DP 24x24 DP 24x30 DP 30x24 DP 30x30 DP | VOSS |  | H-28140 H-28141 H-28142 H-28143 | 16x24 DP Disk 20x24 DP Disk 24x24 DP Disk 24x30 DP Disk | VOSS |
|  | H-28136 H-28137 H-28138 | 16x24 DD Disk 20x24 DD Disk 24x24 DD Disk | M16X1.5 |  | H-28131 H-28132 | T16 57MM Stroke T20 62MM Stroke | M16X1.5 |
|  | H-28151 H-28152 | T9 6200 T12 12600 | Cargo |  | H-28970 H-28971 H-28972 H-28973 H-28974 H-28974D H-28975 H-28975D H-28976 | T 9 T12 T16 T20 T24 T24 LS T30 T30 LS T36 LS | |
|  | H-28192 H-28193 | Aluminum Body Return Spring | | | | | |

HARDWARE KITS





















| | | | | | |
|--|----------------------------------|---|---|----------------------------------|---|
|  | H-24101HD | E-2769HDHD QK-1HD / MK-39 16-12" "Q", "Q-PLUS" HD |  | H-24102HD | E-3710HD, XK-3HD FRUEHAUF "PROPAR" 16-12" "XEM" BRAKE |
|  | H-24103HD | E-1887HD, EK-1HD EATON 16-12" SINGLE ANCHOR PIN BRAKE |  | H-24105 | E-3518, RK-1 MERITOR 18" BRAKE WITH CAST SHOES |
|  | H-24106 | E-7899, RF-3A MERITOR 15" "Q" FRONT |  | H-24107 | E-5139 EF-1 / MK-77 EATON 15" FRONT |
|  | H-24108 | E-5481AS, ES-1 / MK-84 16 12" "EATON" ES I DRIVE AXLE KIT |  | H-24109 | E-10244, ES-2 / MK-105 16 12" "EATON" ES II DRIVE AXLE KIT |
|  | H-24110 | E-10760, EF-2 16 12" "EATON" EF II DRIVE AXLE KIT |  | H-24111 | E-9064, RF-5 / MK-98 15" ROCKWELL Q PLUS BRAKE KIT |
|  | H-24131 | E-5306 LB-7 MK-104 |  | H-24132 | E-2821 EK-2 MK-58 |
|  | H-24139 | E-3869 RF-3 MK-79 |  | H-24165 | E-9644 MF-2 MK-106 MACK WITH MERITOR 16- 12" "Q" FRONT BRAKE |
|  | H-24142 H-24145 | BP Roller Kit 42 mm BP Roller Kit 45 mm |  | H-24160 | MB Roller Kit |
|  | H-24191 | KELLETT A-1768 |  | H-24150 H-24152 | Sertel Roller Kit Osman Koç |















| | | | | | |
|--|-------------------|--|---|------------------|--|
|  | H-24246 | BP Anchor Pin |  | H-24247 | BP Anchor Pin |
|  | H-27151-S | Complete S-Cam Kit Sinter |  | H-27151-P | Complete S-Cam Kit Plastic |
|  | H-27153 | S-mili Toz Lastik ve O ring Kiti |  | H-27155 | S mili Circır Kuyruk bağlantı kiti |
|  | H-27154-S | Spherical Bushing Kit Sinter |  | H-27154-P | Spherical Bushing Kit Plastic |
|  | H-27245 | Spherical Bushing Sinter |  | H-27246 | Spherical Bushing Plastic |
|  | H-27219 | S-mili Burcu ID 38mm Dodge / Hino |  | H-27249 | 30.113.44.34.0 BP Sarı Burç |
|  | H-24300 | B-307 E-2398 |  | H-24309 | B-981 E-1428 |
|  | H-24303 | B-302 E-2768 329 |  | H-24310 | B-220 E-2767 312 |
|  | H-24303 HD | B-349 E-3490A 329K |  | H-24310B | KELLETT A-3020 |
|  | H-24306 | B-972 E3512 |  | H-24311 | B-952 E-3872 |
|  | H-24307 | B-770 E-2805 |  | H-24312 | B-999 E-5122 |
|  | H-24308 | B-982 E-2804 |  | H-24313 | B-953 E3873 |
|  | H-24314 | B-953 E-1418 |  | H-24317 | B-432A E-10197 |
|  | H-24315 | B-434 E-10198 |  | H-24318 | B-433 E-9037 |
|  | H-24316 | B-562 E-2123 |  | H-24319 | B-348 E-9643 |
|  | H-24320 | B-956 E-9063 |  | H-24321 | KELLETT A-1609 |
|  | H-24326 | 03.397.35.05.0 070.211 |  | H-24331 | Ø25x148 |
|  | H-24332 | Ø25x171 |  | H-24333 | Ø25x183 |
|  | H-24327 | BP Retainer Spring Ø18.5x118 |  | H-24328 | BP Retainer Spring Ø18.5x125 |
|  | H-24329 | BP Return Spring Ø35x272 |  | H-24330 | 05.397.46.03.0 070.118 Ø24.5x265 |
|  | H-24367 | 05.397.45.05.0 070.113 Ø22x155 |  | H-24368 | Adjustable Return Spring Ø28.5x237 D5 |
|  | H-24369 | 314.993.11.10 314.993.07.10 100.101 Ø23x182 |  | H-24370 | 81.97610.0271 020.197 Ø30x240 |





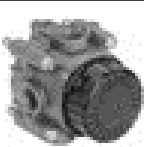















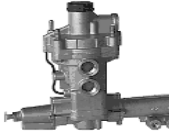









| | | | | | |
|--|----------------|---|---|-----------------|--|
|  | H-24371 | 346.993.03.10 81.97610.0115 100.090 MB Front Ø26x240 |  | H-24372 | 617.993.11.10 81.97610.0208 100.089 MB Rear Ø26x235 |
|  | H-24373 | Volvo 1695 051 Iveco 42480056 Kargo Ege 124 |  | H-24245 | C Klips |
|  | H-24208 | B-151 E-539 |  | H-24211 | B-161 E-3007A 330 |
|  | H-24246 | B-218 E-5305 |  | H-24221 | B-973 E3513 |
|  | H-24213 | B-431 E-5478 |  | H-24226 | B-868 E-1581 |
|  | H-24227 | B-498 E-3227 |  | H-24241 | KELLETT A-3040 |
|  | H-24244 | KELLETT A-1611 |  | H-24210 | B-423 E-747 331 |
|  | H-24201 | B-430K E-5477 |  | H-24202 | B-725 E-3421A |
|  | H-24203 | B-942 E-2217 |  | H-24204 | B-152 E-596A |
|  | H-24205 | B-277 E-3711 |  | H-24209K | 320 Makara |
|  | H-24212 | B-120 E-2766 328 |  | H-24215 | B-311 E-502 |
|  | H-24218 | B-861 E579A |  | H-24219 | B-923 E-3511 |
|  | H-24222 | KELLETT A-1615 |  | H-24231 | B-133 E-2395 |
|  | H-24232 | B-154 E-2803 |  | H-24233 | B-132 E-2396 |
|  | H-24234 | B-950 B-951 E-3871 |  | H-24243 | KELLETT A-3035 |
|  | H-24270 | B-217 E-5304 |  | H-24271 | B-358 E-2399 |
|  | H-24206 | 321 Perno Burcu |  | H-27207 | 313 S-mili Burcu |
|  | H-24214 | B-211 E-2218 |  | H-24216 | B-501 E-1269 |
|  | H-24220 | B-495 E-920 |  | H-24228 | 073 E-4961A |
|  | H-24235 | B-954 E-3874 |  | H-24220 | B-379 E-527 |
| | | | | H-24217 | B-793 E-801 |

















AIR BRAKE VALVES

| | | | | | |
|--|----------------|--|---|----------------|---|
|  | H-28198 | 973 500 003 0 MAX PRESSURE : 10 BAR ALL PORTS 3/8" |  | H-28204 | 973 500 028 0 MAX PRESSURE : 12 BAR 1,21,22: M22 X 1.5 23: M16x1.5 3: Snap On |
| | H-28199 | 973 500 014 0 MAX PRESSURE : 10 BAR 2: 1/2" 1,3: 3/8" |  | H-28205 | 973 500 038 0 MAX PRESSURE : 12 BAR 1,21,22: M22 X 1.5 23: M16x1.5 3: Snap On |
| | H-28200 | 5050007 118.02.00 MAX PRESSURE : 10 BAR ALL PORTS 1/4" |  | H-28206 | 975 001 000 0 Adjustable MAX PRESSURE : 8 BAR ALLPORTS: M22 X 1.5 |
|  | H-28201 | 973 500 000 0 MAX PRESSURE : 12 BAR ALL PORTS: M22 X 1.5 |  | H-28207 | 0 481 009 022 A-4740 |
| | H-28202 | 973 500 006 0 MAX PRESSURE : 10 BAR ALL PORTS: M16 X 1.5 |  | H-28213 | 432 500 020 0 |
| | H-28203 | 973 500 018 0 MAX PRESSURE : 10 BAR 2: M22 X 1.5 1,3: M16X1.5 |  | H-28214 | 475 010 025 0 |
|  | H-28208 | 434 100 124 0 |  | H-28221 | 463 036 000 0 463 036 008 0 |
|  | H-28209 | 434 014 001 0 |  | H-28210 | 434 208 000 0 |
|  | H-28211 | 475 010 300 0 |  | H-28212 | 475 010 400 0 3512MA |
|  | H-28215 | Empty Load Valve 475 604 010 0 |  | H-28216 | 452 002 107 0 |
|  | H-28217 | 475 010 001 0 |  | H-28218 | 463 013 116 0 |
|  | H-28219 | 463 022 020 0 3548MA |  | H-28220 | 463 013 110 0 3548AF |
|  | H-28225 | 934 300 001 0 4018-01 M22x1.5 |  | H-28227 | AE4106 Automatic Drain Valve |
| | H-28226 | 934 300 002 0 4018-02 1/2" |  | H-28228 | 434 300 000 0 Automatic Drain Valve |
|  | H-28231 | 169297, 1705 054 001 0 Transmission Valve |  | H-28232 | 1705 053 002 0 SV3368 |

| | | | | | | |
|--|-----------------|---|---|---|--|--|
|  | H-28240 | 1457276 DAF |  | H-28233 | 0481 009 026 M22x1.5 | |
| | | | | H-28234 | 0481 009 017 M16x1.5 | |
|  | H-28241 | 1303948 DAF |  | H-28244 | 472 172 600 0 | |
|  | H-28242 | SCANIA 1334037 |  | H-28245 | 472 172 606 0 RENAULT SCANIA MAN CARGO BMC | |
|  | H-28247 | 472 173 700 0 DAF |  | H-28246 | 472 172 639 0 MERCEDES ACTROS | |
|  | H-28251 | 432 410 102 0/432 410 104 0 01.120.05.0/01.120.31.0 2810-59 / 2810-60 MAN, MERCEDES, DAF95, NEOPLAN, BMC 8.1 BAR |  | H-28261 | 432 410 118 0 01.120.06.0 / 2810-62 MERCEDES, BMC 8.8 BAR | |
| | | H-28260 | | 432 410 020 0, 432 410 021 0 01.120.07.00, 01.120.12.0 2810-31 9.5 BAR | H-28263 | 432 410 042 0, 01.120.01.0 2810-38 8.5 BAR |
| | | | | H-28264 | 432 410 034 0 01.120.70.0 / 2810-40 12.5 BAR | |
|  | H-28254 | 432 420 000 0 |  | H-28255 | 932 400 003 0 | |
|  | H-28258 | 432 415 014 0 |  | H-28259 | 432 431 191 0 | |
|  | H-28265 | LA 6200 |  | H-28271 | 932 500 007 0 01.130.04.0 2819-10 12 BAR | |
|  | H-28252R | 432 410 020 2, 01.120.16.1 4006-01, R950011, 109994 |  | H-28253 | 1391510 DAF | |
| | H-28252L | 432 901 245 2 K.014712 Left Hand Thread RENAULT |  | H-28254 | 432 410 226 2 SCANIA | |
|  | H-28951 | 432407060 Screw 432407011 Clips 432407012 4842100170 |  | H-28465-3 | 5V 441 043 504 1 | |
| | H-28952 | | | H-28465-4 | 24V 441 043 002 1 | |
| H-28953 | | | | | | |
| H-28954 | | | | | | |
| H-28955 | | | | | | |





| | | | | | | |
|--|--|---|---|---|---|--|
|  | H-28300 H-28301 H-28302 | 975 300 013 0 975 300 110 0 DR3500 |  | H-28303 H-28304 | 975 303 473 0 975 303 060 0 | |
|  | H-28305 | DR 3200 |  | H-28302 | DR 3500 | |
|  | H-28311 H-28312 | 973 011 000 0 973 011 001 0 |  | H-28313 H-28314 | 973 011 200 0 973 011 205 0 (w/Silencer) | |
|  | H-28316 H-28317 | 973 001 010 0 RE1105/1110 973 001 020 0 |  | H-28315 | 973 011 201 0 | |
|  | H-28320 | 973 006 001 0 |  | H-28321 | 973 006 003 0 | |
|  | H-28401 | 973 002 402 0 |  | H-28402 | 973 002 501 0 Adjustable | |
|  | H-28403 H-28404 | 973 009 300 0 M22 VOSS 973 009 010 0 |  | H-28405 H-28406 | 973 009 001 0 11,12,22,41,42: M 22x1,5 43: M 16x1,5 Voss 973 009 002 0 | |
|  | H-28407 | GR201002001 FLK15001010 |  | H-28408 H-28409 | 971 002 000 0 971 002 150 0 | |
|  | H-28411 | 971 002 900 0 |  | H-28410 | 971 002 152 0 | |
|  | H-28413 | 355 094 001 |  | H-28412 | 0 481 026 023 | |
|  | H-28415 H-28416 | L621 L622 |  | H-28418 | 463 084 031 0 | |
|  | H-28420 | 90054007 |  | H-28421 | KN27000 S9978 L6223 | |
|  | H-28422 H-28423 H-28424 H-28425 H-28426 | 441 050 008 0 441 050 010 0 441 050 011 0 441 050 012 0 441 050 013 0 | BENZ RENAULT MAN ACTROS IVECO |  | H-28427 H-28428 H-28429 H-28430 | 441 050 100 0 441 050 101 0 441 050 120 0 441 050 121 0 |

| | | | | | |
|---|----------------|---------------------------|---|----------------------------------|---|
|  | H-28431 | 464 006 100 0 |  | H-28432 | 464 006 002 0 |
| | | |  | H-28433 | 464 006 003 0 |
|  | H-28434 | SV 1307 |  | H-28435-1 | SV 1294 |
| | | |  | H-28435-2 | SV 1310 |
|  | H-28436 | 464 002 330 0 |  | H-28437 | SV1280 |
|  | H-28438 | 464 007 010 0 |  | H-28439 | 464 007 001 0 |
|  | H-28440 | 464 007 011 0 | | | |
|  | H-28441 | 475 715 500 0 RL3523BB |  | H-28445 | 475 711 075 0 |
|  | H-28446 | 475 714 500 0 |  | H-28447 | 475 712 004 0 |
|  | H-28448 | 475 712 000 0 |  | H-28449 H-28450 | 475 710 008 0 475 710 020 0 475 712 022 0 |
|  | H-28451 | AE-4162 |  | H-28453 | 934 702 210 0 |
| | H-28452 | AE-4170 | | H-28454 | 934 702 250 0 |
| | H-28457 | AE-4158 | | | |
|  | H-28455 | 934 702 300 0 |  | H-28458 | AE-4613 |
| H-28456 | 934 702 002 0 | H-28459 | | AE-4612 | |
| | | | H-28460 | AE-4604 | |
| | | | H-28461 | AE-4605 | |
|  | H-28462 | 934 713 004 0 |  | H-28463 | 934 714 140 0 |
|  | H-28464 | AE 4440 3515 012 001 |  | H-28465 | 934 705 005 0 01.111.02 |
|  | H-28466 | AE4510 |  | H-28469 | AE4800 |
| | H-28467 | AE4528 472 195 0310 | | | |
|  | H-28475 | 461 315 248 0 |  | H-28476 | 461 315 258 0 |
|  | H-28477 | 461 319 271 0 |  | H-28478 | 461 319 250 0 |

| | | | | | |
|--|--|---|---|--|--|
|  | H-28479 | 461 319 260 0 |  | H-28480 | 461 319 008 0 |
|  | H-28481 | 461 315 264 0 |  | H-28486 | 461 491 102 0 |
|  | H-28492 | MB 4690 |  | H-28493 H-28494 | DX 95 B DX 75 BA |
|  | H-28496 | DX 75BAY |  | H-28497 | 286171 E-6 |
|  | H-28498 | 277863 |  | H-28499 | 461 319 274 0 |
|  | H-28500 H-28501 | MB 4630 461 315 019 0 MB 4636 |  | H-28502 | MB 4803 |
|  | H-28503 H-28504 H-28505 H-28506 H-28507 | 461 315 008 0 461 315 004 0 461 315 042 0 461 315 053 0 461 315 012 0 |  | H-28508 H-28509 H-28510 H-28511 | 461 317 024 0 461 317 000 0 461 317 002 0 461 317 008 0 |
|  | H-28512 | 461 317 051 0 |  | H-28514 | 102 327 500 0 |
|  | H-28515 | 461 313 050 0 MB4434 |  | H-28517 | 950 320 020 MB 4821 |
|  | H-28521 | 961 723 001 0 |  | H-28522 | 961 722 252 0 961 722 258 0 |
|  | H-28523-1 H-28523-2 | 961 723 108 0 961 723 208 0 |  | H-28524 | 961 723 005 0 |
|  | H-28525 | 961 723 009 0 |  | H-28526-1 H-28526-2 | 961 723 104 0 961 723 125 0 |
|  | H-28527 | HB 1176 |  | H-28528 H-28529 | HB 1258 HB 1350 |
|  | H-28531 | 961 722 150 0 |  | H-28533 H-28530 | 961 722 232 0 961 722 151 0 |

| | | | | | |
|--|----------------------------------|---------------------------------|---|----------------|---------------|
|  | H-28532 | 961 722 212 0 |  | H-28535 | 961 701 100 0 |
| | | | | H-28536 | 961 701 105 0 |
|  | H-28544 | 463 032 020 0 |  | H-28581 | 352 045 001 |
|  | H-28582 | 963 001 051 0 |  | H-28583 | 971 002 900 0 |
|  | H-28810 H-28812 | 4S/2M 400 500 081 0 2S/2M |  | H-28801 | ABS Kit |

AMERICAN AIR BRAKE VALVES

| | | | | | |
|--|----------------|--|---|----------------|---|
|  | H-30000 | 432 413 001 0 R955205 |  | H-30015 | 109994 |
|  | H-30001 | 109685 AD-9 AIR DRYER |  | H-30016 | 107794 AD-9 AIR DRYER CARTRIDGE |
|  | H-30116 | Quick Release Valve 289144 |  | H-30082 | Single Check Valve KN23000 |
|  | H-30152 | 280241 Control Valve |  | H-30031 | E-245, M-678 Pressure Regulator w/Filter |
|  | H-30110 | KN32005 229859 973 500 003 0 PORTS SUP: 3/8"PT PORTS DEL: 3/8" PT |  | H-30112 | KN32041 289714 973 500 011 0 PORTS SUP.: 1/4"PT PORTS DEL.: 3/8"PT |
| | H-30111 | KN32011 229860 973 500 014 0 PORTS SUP: 1/2"PT PORTS DEL: 3/8" PT | | H-30114 | 107881 PORTS SUP: 1/4"PT PORTS DEL: 3/8"PT PORTS EXH: 1/2"PT |
| | H-30115 | 229813 PORTS SUP: 3/8"PT PORTS DEL: 1/4" PT | | H-30113 | 800333 PORTS SUP 1(11): 1/2"NPT PORTS DEL(2): 1/2"NPT |
|  | H-30050 | 279000, KN34060 Protection Valve |  | H-30080 | 280809 Double Check Valve |
|  | H-30180 | SR2 Spring Brake Valve 103061 |  | H-30181 | SR2 Spring Brake Valve V287376 S-A150 |

| | | | | | |
|--|----------------|--|---|----------------|--|
|  | H-30176 | SR5 Spring Brake Valve V065437 |  | H-30178 | SR4 Spring Brake Valve V101112 S-A151 |
|  | H-30177 | SR5 Spring Brake Valve 102761 |  | H-30179 | SR4 Spring Brake Valve V101622 |
|  | H-30265 | R-12H Relay Valve Horizontal V103009 |  | H-30272 | R-12V Relay Valve Vertical V102626 |
|  | H-30266 | R-14H Relay Valve Horizontal 103010 |  | H-30267 | R-14V Relay Valve Vertical 103028 |
|  | H-30195 | Emergency Relay Valve KN30300 |  | H-30200 | Emergency Relay Valve 110200 |
|  | H-30198 | Emergency Relay Valve 281865 |  | H-30508 | Transmission Splitter 19974 |
|  | H-30476 | D2 GOVERNOR V275491 |  | H-30503 | Leveling Valve 90554241 |
|  | H-30261 | RG2H Relay Valve Horizontal VKN28500, S-6085 |  | H-30261 | RG2V Relay Valve Vertical VKN28510, S-6085 |

CLUTCH SERVO

| | | | | | |
|--|-----------------|---|---|-----------------|--|
|  | H-286005 | APGA1605, 970 190 005 0 09.902.00.0, 3013-01 FORD 2626, 3226, 3227 |  | H-286010 | APGA1605, 09.902.11.0 CARGO 24, 25 |
| | H-286006 | APGA1605, 09.902.10.0 BMC Fatih, Dodge, ASKAM CARGO 2517, 2520 |  | H-286102 | 970 051 102 0 09.905.02.0 3002-01, BMC PRO, DAF |
|  | H-286107 | 970 051 107 0, 09.908.01.0 3005-09 DAF SCANIA |  | H-286111 | 970 051 111 0, 09.905.00.0 3001-01 MAN F80, F81 |
|  | H-286114 | 970 051 114 0, 09.905.03.0 3002-02, DAF, Iveco, MAN, Neoplan, Renault, Scania, ZF |  | H-286124 | 970 051 124 0, 09.908.00.0 3005-01, RENAULT, BMC, SCANIA |
|  | H-286128 | 970 051 128 0, 09.908.07.0 3005-03 MERCEDES |  | H-286129 | 970 051 129 0, 09.905.06.0 3001-03 DAF |
|  | H-286131 | 970 051 131 0, 09. 910.00.0 3008.01 DAF, Renault, Scania, MB Actros, |  | H-286151 | 970 051 151 0, 09.919.00.0 3003-01 MERCEDES, IVECO, DAF, EUROCARGO |
|  | H-286158 | 970 051 158 0, 09. 920.00.0 3011.01 MERCEDES |  | H-286159 | 970 051 159 0, VG3361 09. 920.01.0, 3011.02 MERCEDES |















| | | | | | |
|--|------------------|---|---|------------------|---|
|  | H-286164 | 970 051 164 0, 09.908.12.0, 3005-10 MERCEDES |  | H-286406 | 970 051 406 0, VG3262 09.918.20.0 MAN, DAF OTOKAR |
|  | H-286407 | 970 051 407 0 09.918.02.0, 3021-06 ZF |  | H-286412M | 970 051 412 0, 09.918.11.0M 3021-16-M MAN TGA MINERAL OIL (PENTOSIN) |
|  | H-286414 | 970 051 414 0, VG3261 09.918.00.0, 3021-04 DAF MAN RENAULT SCANIA |  | H-286422 | 970 051 422 0, 09.918.05.0 3021-18 RENAULT VI PREMIUM |
|  | H-286424 | 970 051 424 0, 09.918.06.0, 3021-08 BMC PRO ZF, MAN, SCANIA, DAF IVECO, VAN HOOL |  | H-286436 | 970 051 436 0 09.918.03.0, 3021-21 MERCEDES, DAF |
|  | H-286438 | 970 051 438 0 09.918.07.0, 3021-05 RENAULT VI, Magnum, Premium, DAF, IVECO |  | H-286431M | 970 051 431 0, 09.918.10.0M MB AXOR MINERAL OIL (PENTOSIN) |
|  | H-286441M | 970 051 441 0, 09.918.09.0M MB AXOR MINERAL OIL (PENTOSIN) |  | H-286455 | 970 051 455 0 09.918.12.0, 3021-28 CARGO After 2010, IVECO BMC PRO |
|  | H-287208 | VG3208 09.914.00.0, 3007-01 MAN F90, 19, 22, 24, IVECO |  | H-287200 | VG3200, 970 051 111 0 09.913.00.0, 3006-01 MAN |
|  | H-287262 | VG3262, 970 051 406 0 09.913.02.0, 3006.05 MAN, DAF, OTOKAR |  | H-287261 | VG3261, 970 051 414 0 09.914.01.0, 3007.05 MAN, DAF |
|  | H-287265 | VG3265 09.913.01.0, 3006-04 BMC BUS, MAN, ASKAM |  | H-287264 | VG3264 09.914.11.0, 3007-03 DAF LEYLAND IVECO EUROCARGO STRALIS |

BRAKE DRUMS

| | | | | | |
|--|----------------|--|---|-----------------------------------|---|
|  | H17087 | 3687X |  | H-17101 | 8656 122600 68897 51952-11 |
|  | H-17102 | 3600AX 123207 66864B 53033-01 |  | H-17103 | 2983C 122222 67518 52230-10 |
|  | H-17104 | 3197 61788 |  | H-17106 | 2577A 120754 61780 51951-10 |
|  | H-17108 | 3800X 123448 65545B 54214-018 |  | H-17109 H-17109B | 3141 / 3141B 122550 66895 52705-30 |
|  | H-17110 | 3710X |  | H-17114 | 2705 012582 62200 52020-01 |

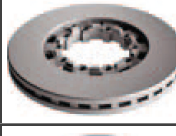
| | | | | | |
|--|-----------------|--|---|-----------------|--|
|  | H-17116 | 3295A 122683 68981B 52120-12 |  | H-17117 | 3018A 122126 68730 52327-10 |
|  | H-17119 | 3166 122607 66893 53026-01 |  | H-17121 | 3120 120877 60876 52877-11 |
|  | H-17128 | 3721AX 61528B |  | H-17129 | 3771X 65565B 8071943 |
|  | H-17154 | 3754X |  | H-17158 | 3758X |
|  | H-17200C | BPW Trailer Pilot Axle |  | H-17201S | Serin Pilot Axle |
|  | H-17202 | 03.106.77.63 3565 |  | H-17203 | 03.106.77.59 |
|  | H-17204 | 03.106.67.01 |  | H-17205 | 03.106.67.01 |
|  | H-17221 | 3464230501 3464230101 |  | H-17222 | 3464230601 3464230001 |
|  | H-17223 | 3054210001 |  | H-17224 | 3054230801 |
|  | H-17225 | 3054230301 3054230401 |  | H-17226 | 617 423 0101 |
|  | H-17227 | 617 423 0201 |  | H-17228 | 624 421 0201 |
|  | H-17229 | 3014230001 - 3014230801 3014230901 - 3014231201 3054230401 - 3054230301 3074230101 - 3054230401 |  | H-17230 | 3014230301 3014230101 3814230201 3644210001 |
|  | H-17231 | 3464210301 3874210001 3874210101 |  | H-17232 | 3054210101 3054210401 |

DISK ROTOR

| | | | | | |
|--|----------------|--|---|----------------|--|
|  | H-17401 | 0403 / 0404 / TOURISMO 3564211012 - 3564211212 3564210312 - 3054210312 |  | H-17402 | ACTROS/AXOR/CITARO 9424212112 – 9424211212 9424210912 - 9424211012 |
|  | H-17403 | IVECO EUROTECH 1907631-1908614-1908729 7173317-7181111-2991979 |  | H-17404 | IVECO EUROSTAR 7182305-7179778-7192305 1906461-2992470-2996329 |
|  | H-17405 | IVECO STRALIS 2995812-2996328 7189476-7185503 |  | H-17406 | RENAULT MAGNUM PREMIUM 5010216437 |
|  | H-17407 | DAFCF-85 XF-95 1387439 - 1640561 |  | H-17408 | BPW ECOPLUS 308835030 |
|  | H-17409 | BPW / FRUEHAUF 308835050 – 308835010 308835057 |  | H-17410 | FRUEHAUF |
|  | H-17411 | SAF DORSE 19.5" 4079001001 |  | H-17412 | SAF DORSE 22.5" 4079001300 – 4079001301 4079001302 |
|  | H-17413 | VOLVO FH12 85103803 – 85110496 20515093 |  | H-17414 | VOLVO FH13 / EURO5 85103854 |
|  | H-17415 | CARGO 608 / 609 /611 6172906 |  | H-17416 | SCANIA 420 1402272 - 1386686 |

S-CAM

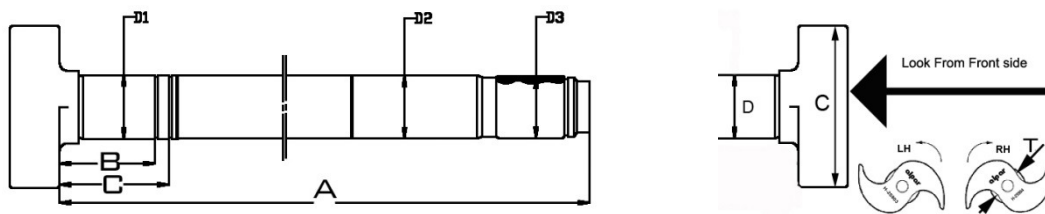

| REF# | REF | APPLICATION | A | D1 | D2 | D3/Spline |
|------------------------|------------------|-------------|----------|--------|----------|-----------|
| H-25401LH H-25401RH | E-9649 E-9650 | 16 ½ Q+ | 8 9/16" | 1 ½" | 1 ½" | 1 ½"-28 |
| H-25402LH H-25402RH | E-9659 E-9660 | 16 ½ Q+ | 11 1/18" | 1 ½" | 1 ½" | 1 ½"-28 |
| H-25403LH H-25403RH | E-9661 E-9662 | 16 ½ Q+ | 11 1/2" | 1 ½" | 1 ½" | 1 ½"-28 |
| H-25404LH H-25404RH | E-1563 E-1564 | Propar 16 ½ | 16 1/8" | 1 5/8" | 1 19/32" | 1 5/8-37 |
| H-25405LH H-25405RH | E-2441 E-2442 | 16 ½ Q+ | 17 5/16" | 1 5/8" | 1 1/2" | 1 ½"-28 |

| | | | | | | |
|------------------------|--|-------------------------------|----------|--------|--------|-----------|
| H-25406LH H-25406RH | E-2445 E-2446 | 16 ½ Q+ | 24 1/16" | 1 5/8" | 1 1/2" | 1 ½"-28 |
| H-25407LH H-25407RH | E-9059 E-9060 | 16 ½ Q+ | 23 3/4" | 1 5/8" | 1 1/2" | 1 ½"-28 |
| H-25408LH H-25408RH | E-1424 E-1425 | 16 ½ Q+ | 20 3/8" | 1 5/8" | 1 1/2" | 1 ½"-10 |
| H-25409LH H-25409RH | E-5510 E-5511 | 16 ½ Q+ | 24 1/16" | 1 5/8" | 1 1/2" | 1 ½"-28 |
| H-25601LH H-25602LH | 623 421 0136/236 81.503.010.223/224 | MERCEDES / MAN TRUCK FRONT | 253 mm | 42 | 42 | 26 Spline |
| H-25603LH H-25604LH | 81.503.010.225 81.503.010.226 | MERCEDES / MAN BUS FRONT | 226 mm | 42 | 42 | 26 Spline |
| H-25611LH H-25612LH | 346 423 1136 346 423 1236 | MERCEDES / MAN TRUCK REAR | 541 mm | 42 | 42 | 26 Spline |
| H-25613LH H-25614LH | 81.503.010.271 81.503.010.272 | MERCEDES / MAN BUS REAR | 525 mm | 42 | 42 | 26 Spline |
| H-25829LH H-25830RH | 05.097.05.23 05.097.05.24 | BPW | 640 mm | 42 | 42 | 1 ½"-10 |
| H-25903LH H-25904RH | PILOT AXLE | SERIN BPW AXLE | 640 mm | 42 | 42 | 1 ½"-10 |
| H-25905LH H-25906RH | PILOT AXLE | SERIN BPW AXLE | 700 mm | 42 | 42 | 1 ½"-10 |
| H-25907LH H-25908RH | PILOT AXLE | SERIN BPW AXLE | 750 mm | 42 | 42 | 1 ½"-10 |
| H-25953LH H-25954RH | LOW RIDER | SERIN BPW AXLE | 640 mm | 42 | 42 | 1 ½"-10 |
| H-25955LH H-25956RH | LOW RIDER | SERIN BPW AXLE | 700 mm | 42 | 42 | 1 ½"-10 |
| H-25957LH H-25958RH | LOW RIDER | SERIN BPW AXLE | 750 mm | 42 | 42 | 1 ½"-10 |





HUB CAPS

| | | | | | |
|--|----------------------------|---------------------------------|---|----------------|-----------------|
|  | H-18941 | 4009 SIX HOLES HUB CAP |  | H-18962 | Steel Hub Cap |
|  | H-18942 | 4095 Hub Cap |  | H-18944 | 4249 Hub Cap |
|  | H-18943 | 4075 Hub Cap SPIN ON |  | H-18945 | 4024 Hub Cap |
|  | H-18950 | 4195 Hub Cap |  | H-18949 | 5 HOLES HUB CAP |
|  | H-18950 H-18951 | 6 Holes Gasket Universal Gasket |  | H-18952 | Hub Cap PLUG |

ABS / EBS / ELECTRIC CABLE & ACCESSORIES

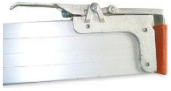
| | | | | | |
|--|-----------------|--|---|-----------------|---|
|  | H-95011 | 0.40M 90 Degree SENSOR |  | H-95021 | 0.40M Straight SENSOR |
| | H-95012 | 1.0 M 90 Degree SENSOR | | H-95022 | 1.0 M Straight SENSOR |
| | H-95013 | 1.75M 90 Degree SENSOR | | H-95023 | 1.75M Straight SENSOR |
| | H-95014 | 2.5 M 90 Degree SENSOR | | H-95024 | 2.5 M Straight SENSOR |
|  | H-95048 | Sensor Extension 3.8m |  | H-95142 | 449 125 120 0 ABS Power Cable 5 pin 12 m |
| | H-95049 | Sensor Extension 5.0m | | H-95143 | 449 126 120 0 ABS Power Cable 7 pin 12 m |
|  | H-95101A | 7 Pin Electric N type Aluminum Plug Screw Type |  | H-95103A | 7 Pin Electric Socket N Type |
|  | H-95102A | 7 Pin Electric S Type Aluminum Plug Screw Type |  | H-95104A | 7 Pin Electric Socket S Type |
|  | H-95101P | 7 Pin Electric N type Plastic Plug. Screw Type |  | H-95103P | 7 Pin Electric Socket N Type |
|  | H-95102P | 7 Pin S Type Plastic Plug Screw Type |  | H-95104P | 7 Pin Electric Socket S Type |
|  | H-95111A | 4 m 7 Pin N Type Aluminum |  | H-95111P | 4 m 7 Pin N Type Plastic |
| | H-95112A | 4.5 m 7 Pin N Type Aluminum | | H-95112P | 4.5 m 7 Pin N Type Plastic |
| | H-95113A | 5.5 m 7 Pin N Type Aluminum | | H-95113P | 5.5 m 7 Pin N Type Plastic |
|  | H-95121A | 4 m 7 Pin S Type Aluminum |  | H-95121P | 4 m 7 Pin S Type Plastic |
| | H-95122A | 4.5 m 7 Pin S Type Aluminum | | H-95122P | 4.5 m 7 Pin S Type Plastic |
| | H-95123A | 5.5 m 7 Pin S Type Aluminum | | H-95123P | 5.5 m 7 Pin S Type Plastic |
|  | H-95041 | 446 008 234 0, 6-30045.40 7 PIN ABS/EBS 4 m |  | H-95044 | 6-30039.40 15 PIN ELECTRIC 4 m |
| | H-95042 | 446 008 243 0, 6-30045.45 7 PIN ABS/EBS 4.5 m | | H-95045 | 6-30039.45 15 PIN ELECTRIC 4.5 m |
|  | H-95043A | 6-30057.40 15 pin Aluminum Plug 4 m |  | H-95043P | 6-30058.40 15 pin Plastic Plug 4 m |
| | H-95044A | 6-30057.45 15 pin Aluminum Plug 4.5 m | | H-95044P | 6-30058.45 15 pin Plastic Plug 4.5 m |
|  | H-95064 | 7 Pin ABS EBS Plug 12 / 24 V |  | H-95066 | 15 Pin Adapter Cable Plug |
|  | H-95065 | 7 Pin ABS EBS Socket 12 / 24 V |  | H-95067 | 15 Pin Adapter Cable Socket |
|  | H-95068 | 15 Pin Adapter Socket |  | H-90111 | American ABS Cable |



CARGO CONTROL

| | | | | | |
|--|---------|----------------------------------|---|---------|--------------------------------|
|  | H-69500 | LOAD SEPARATION POST WITH CLAMPS |  | H-69501 | CLAMP for LOAD SEPARATION POST |
|  | H-69503 | Steel / 220-280 cm |  | H-69504 | Aluminum / 220-280 cm |

PNEUMATIC FITTINGS











| | | | | | | | |
|--|---|------------|-------------------|---|-------------|-------------------|-------------|
|  | H-28001 | 4 x 4 mm | Straight Union |  | H-28021 | 4 mm | Elbow Union |
| | H-28002 | 4 x 6 mm | | | H-28022 | 6 mm | |
| H-28003 | 4 x 8 mm | H-28023 | 8 mm | | | | |
| H-28004 | 6 x 6 mm | H-28024 | 10 mm | | | | |
| H-28005 | 8 x 6 mm | H-28025 | 12 mm | | | | |
| H-28006 | 8 x 8 mm | H-28026 | 16 mm | | | | |
|  | H-28007 | 9 x 9 mm | T Union | H-28041 | 4 mm | T Union | |
| | H-28008 | 10 x 8 mm | | H-28042 | 6 mm | | |
| | H-28009 | 10 x 10 mm | | H-28043 | 8 mm | | |
| | H-28010 | 10 x 12 mm | | H-28044 | 10 mm | | |
| | H-28011 | 12 x 12 mm | | H-28045 | 12 mm | | |
| | H-28012 | 16 x 16 mm | | H-28046 | 16 mm | | |
| |  | H-28031 | | 4 mm | Cross Union | | H-28051 |
| H-28032 | | 6 mm | H-28052 | 6 mm | | | |
| H-28033 | | 8 mm | H-28053 | 8 mm | | | |
| H-28034 | | 10 mm | H-28054 | 10 mm | | | |
| H-28035 | | 12 mm | H-28055 | 12 mm | | | |
|  | H-28092 | 1/8"x8 | Threaded Tee | H-28095 | 1/8"x6 | Side Threaded Tee | |
| | H-28093 | 1/4"x8 | | H-28096 | 1/8"x8 | | |
| | | | | H-28097 | 1/4"x8 | | |
|  | H-28070 | 1/8"x6 | Threaded Straight | H-28081 | 1/8"x6 | Threaded Elbow | |
| | H-28071 | 1/8"x8 | | H-28082 | 1/8"x8 | | |
| | H-28072 | 1/4"x6 | | H-28083 | 1/4"x6 | | |
| | H-28073 | 1/4"x8 | | H-28084 | 1/4"x8 | | |
| | H-28074 | 1/4"x12 | | H-28085 | M12-1.0x6 | | |
| | H-28075 | M12-1.0x6 | | H-28086 | M12-1.0x8 | | |
| | H-28076 | M12-1.0x8 | | H-28087 | M16-1.5x8 | | |
| | H-28077 | M16-1.5x8 | | H-28088 | M16-1.5x12 | | |
| | H-28078 | M16-1.5x12 | | H-28089 | M22-1.5x8 | | |
| | H-28079 | M22-1.5x8 | | H-28090 | M22-1.5x12 | | |
| | H-28080 | M22-1.5x12 | | | | | |

LANDING GEARS

| | | | | | | | |
|--|---------|--------|--------|---|---------|--------|--------|
|  | H-84101 | T Shoe | 25 Ton |  | H-84151 | T Shoe | 25 Ton |
| | H-84102 | T Shoe | 28 Ton | | H-84152 | T Shoe | 28 Ton |
| | H-84103 | T Shoe | 30 Ton | | H-84153 | T Shoe | 30 Ton |
| | H-84111 | S Shoe | 25 Ton | | H-84161 | S Shoe | 25 Ton |
| | H-84112 | S Shoe | 28 Ton | | H-84162 | S Shoe | 28 Ton |
| | H-84113 | S Shoe | 30 Ton | | H-84163 | S Shoe | 30 Ton |
| | H-84121 | A Shoe | 25 Ton | | H-84171 | A Shoe | 25 Ton |

| | | | | | | | |
|---|---------|--------|--------|---|---------|--------|--------|
|  A  R | H-84122 | A Shoe | 28 Ton |   | H-84172 | A Shoe | 28 Ton |
| | H-84123 | A Shoe | 30 Ton | | H-84173 | A Shoe | 30 Ton |
| | H-84131 | R Shoe | 25 Ton | | H-84181 | R Shoe | 25 Ton |
| | H-84132 | R Shoe | 28 Ton | | H-84182 | R Shoe | 28 Ton |
| | H-84133 | R Shoe | 30 Ton | | H-84183 | R Shoe | 30 Ton |

U-JOINTS

| | | | | | |
|--|---------|---------------------------------|--|---------|---------------------------------|
|   | H-83101 | 5-170X/338/G5-170x |   | H-83102 | 5-324X/480/C P18N96 |
| | H-83103 | 5-279X/333/C p16NS | | H-83104 | 5-674X/475/C P16SI |
| | H-83105 | 5-280X/334/C P16NS | | H-83106 | 5-281X/381/C P18NS |
| | H-83107 | 5-407X/376/C P176NS | | H-83108 | 5-675X/476/C P17SI |
| | H-83109 | 5-676X/478/C P18SI | | H-83110 | 5-677X477/C P176SI |
| | H-83111 | 5-9001X | | H-83112 | 5-326X/H S798 |
| | H-83113 | SPL-250 | | H-83114 | SPL-170 |
|  | H-83209 | HB88509 |  | H-83210 | HB88510 |
| | H-83212 | HB88512 | | H-83017 | GUN-46 / GUN46 / U J124 |
|   | H-83001 | ST-1540 |   | H-83018 | GU-1780 |
| | H-83002 | ST-1640 | | H-83019 | GU-1720 |
| | H-83003 | ST-1948 | | H-83020 | GU-9050 |
| | H-83004 | GUS-2 | | H-83021 | GUT-21 / T2977 / U J230 |
| | H-83005 | GU-1700 | | H-83022 | GUM-93 / S32102A |
| | H-83006 | GU-1760 | | H-83023 | GU-2200 / 331 / GU2200 / H S182 |
| | H-83007 | GUD-88 / GU88 / U J226 | | H-83024 | GU-2050 / 330 / GU2050 / H S179 |
| | H-83008 | GU-500 / 341 / GU500 / H S194 | | H-83025 | GU-1740 |
| | H-83009 | GU-7280/4 / U728/4 | | H-83026 | GU-7431 |
| | H-83010 | GUS-1 | | H-83027 | GUM-75 |
| | H-83011 | GUS-7 | | H-83028 | GUMZ-3(4) / T M3293 / U J414 |
| | H-83012 | GUM-88 | | H-83029 | GU-2010 |
| | H-83013 | GUT-12 / T2680C / U J210 | | H-83030 | GU-2300 / GU2300 / 351 / H S263 |
| | H-83014 | GUMZ-9 | | H-83031 | GU-7430 U743 / H S222 |
| | H-83015 | GU-1100 / 344 / GU1100 / H S195 | | H-83032 | GU-7300 / U730 / H S480 |
| | H-83016 | GU-1000 / 369 / GU1000 / H S166 | | H-83042 | GU-7655 |
| H-83033 | GU-7440 | H-83043 | GU-5000 / GU5000 / H S337 | | |

| | | | | | |
|--|---------|---------------------------------|--|---------|------------------|
| | H-83034 | GU-3500 / GU3500 / 370 / H S176 | | H-83044 | GU-3810 |
| | H-83035 | GU-7470 | | H-83045 | GU-7560 / H S282 |
| | H-83036 | GU-3800 | | H-83046 | GU-7600 |
| | H-83037 | GU-3840 | | H-83047 | GU-7610 / H S284 |
| | H-83038 | GU-7530 / H S260 | | H-83048 | GU-6130 |
| | H-83039 | GU-8100 / H S266 | | H-83049 | GU-7630 / H S289 |
| | H-83040 | GU-7648 | | H-83050 | GU-8150 |
| | H-83041 | GU-7650 / H S272 | | H-83051 | GS-124X |



BOLT / NUT

| | | | | | |
|--|---|---|--|--|--|
|  | H-14101 L&R | E-7895 708-9/ M-128 1 1/8x16" / 3/4"-16 |  | H-14106 L&R | E-5978 978 1 1/8x16" / 3/4"-16 |
| | H-14102 L&R | E-7896 896/M-1301 1/8x16" / 3/4"-16 |  | H-14202 L&R | Mitsubishi / ISUZU M30x1.5 |
| | H-14103 L&R | E-7897 897/M-132 1 1/8x16" / 3/4"-16 |  | H-14201 L&R | E-5977 891/M-126 1 1/8x16" |
|  | H-13302 | E-4963 / 716 3/4 10 |  | H-14203 L&R | Mitsubishi / Isuzu / Hino M30x1.5 |
|   | H-13101 | E-9021 / 921 7/8" 14 |   | H-15101 | M22x1.5 H26 |
| | H-13102 | E-10235 / 919 M20X1.5 | | H-15102 | M22x1.5 H30 |
| | H-13103 | E-5991 / 881M M22X1.5 | | H-15104 | M22x1.5 H32 |
| | H-13104 | E-6000A / 333BT M-3203 M22X1.5 | | H-15106 | M24x1.5 H32 |
| | H-13105 | E-9020 / 920 / M-3979 M22X1.5 | | H-15107 | M24x2 H32 |
|  | H-12301 | E6036/164/M-3215/W-544 C006036 3 1/2" 88.9 mm |  | H-11204 | E-4956A / 715 / M-39 |
| | H-12302 | E6035/162/M3216/W545 C006035 3 15/16" 123.8 mm | | H-11205 | E-5706 / 411 / M-1102 |
| | H-12303 | E10676/676/M3667/W1327/ C10676 4 1/4" 108 mm |  | H-15215 H-15216 | M22x1,5 Pilot 100 mm Wheel Bolt 100 mm |
| | H-12304 | E6034/160/M-3217/W546 C006034 4 25/32"121.45mm |  | H-15216 H-15217 H-15218 | 110 mm 90 mm 80 mm |
|  | H-15211 H-15212 H-15213 H-15214 H-15215 | 110 mm 105 mm 100 mm 98 mm 77 mm |  | H-15211F H-15212F H-15213F H-15214F H-15215F | 110 mm 105 mm 100 mm 98 mm 77 mm |

AIR SPRINGS

| | | | | | |
|--|---------|----------------------|---|---------|--------------------------|
|  | H-47813 | 813 TRAILER AXLES |  | H-47825 | Trailer Lift Axle Spring |
|--|---------|----------------------|---|---------|--------------------------|

AIR BRAKE PARTS & ACCESSORIES

| | | | | | | | |
|--|--|--|---------------------------------|---|--|---|-----------------------------------|
|  | H-28931 H-28932 H-28933 H-28934 H-28935 H-28936 H-28937 H-28938 | 4 X 6 6 X 8 8 X 10 9 X 12 11 X 14 12 X 15 12 X 16 14 X 18 | AIR BRAKE HOSE METRIC |  | H-28941 H-28942 H-28944 H-28944 H-28945 H-28946 H-28947 H-28948 | 1/8" x 0.023" 5/32" x 0.032" 3/16" x 0.035" 1/4" x 0.040" 5/16" x 0.040" 3/8" x 0.062" 1/2" x 0.062" 5/8" x 0.092" | AIR BRAKE HOSE AMERICAN |
|  | H-28901 H-28903 | M16 Air Coil Emergency M22 | |  | H-28902 H-28904 | M16 Air Coil Service M22 | |
|  | H-28911 H-28913 | Air Coil Emergency | |  | H-28912 H-28914 | Air Coil Service | |
|  | H-28921 | 452 200 011 0 Standard Gladhand Emergency Red M22x1.5 | |  | H-28927 | 452 200 021 0 Standard Gladhand Emergency Red M16x1.5 | |
|  | H-28922 | 452 200 012 0 Standard Gladhand Service Yellow M22x1.5 | |  | H-28928 | 452 200 022 0 Standard Gladhand Service Yellow M16x1.5 | |
|  | H-28923 | 452 200 211 0 Automatic Gladhand Emergency Red M22x1.5 | |  | H-28929 | 452 200 221 0 Automatic Gladhand Emergency Red M16x1.5 | |
|  | H-28924 | 452 200 212 0 Automatic Gladhand Service Yellow M22x1.5 | |  | H-28930 | 452 200 222 0 Automatic Gladhand Service Yellow M16x1.5 | |
|  | H-28925 | 952 201 001 0 Gladhand Emergency Red With Filter | |  | H-25926 | 952 201 002 0 Gladhand Service Yellow With Filter | |
|  | H-28911 | Standard Gladhand Emergency | |  | H-28912 | Standard Gladhand Service | |
|  | H-28916 | 38 deg Emergency Gladhand TEC 9216 3/8" / 3/8" | |  | H-28913 | Standard Gladhand Universal | |
|  | H-28917 | 38 deg Service Gladhand TEC 9217 3/8" / 3/8" | |  | H-28920 | Gladhand Seal Black | |

The names and the part numbers used in this catalog are for reference purposes only. They are the others' name and trademark property. They are not for soliciting any sales.



wsp | **wedex**
PARTS

Altun Otomotiv - Levent Altuntaş

Horozluhan Mh. Güngördü Sk. No: 12 KONYA / TURKEY

Phone: +90 332 251 88 89

Fax: +90 332 251 88 90

www.wedexparts.com

info@wedexparts.com